

Mod. CG.GEN MAXI

**GENERATORE di VAPORE ELETTRICO
GENERATEUR de VAPEUR ELECTRIQUE
STEAM ELECTRIC GENERATOR**

HIGHLIGHTS

**CALDAIA VERTICALE 62 Lt
VERTICAL BOILER 62 Lts
CHAUDIERE VERTICALE 62 Lts**

**CONTROLLO ELETTRONICO a 2 SONDE
ELECTRONIC CONTROL at 2 PROBES
CONTROL ELECTRONIQUE à 2 SONDÉS**

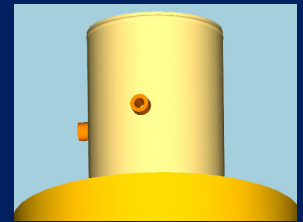
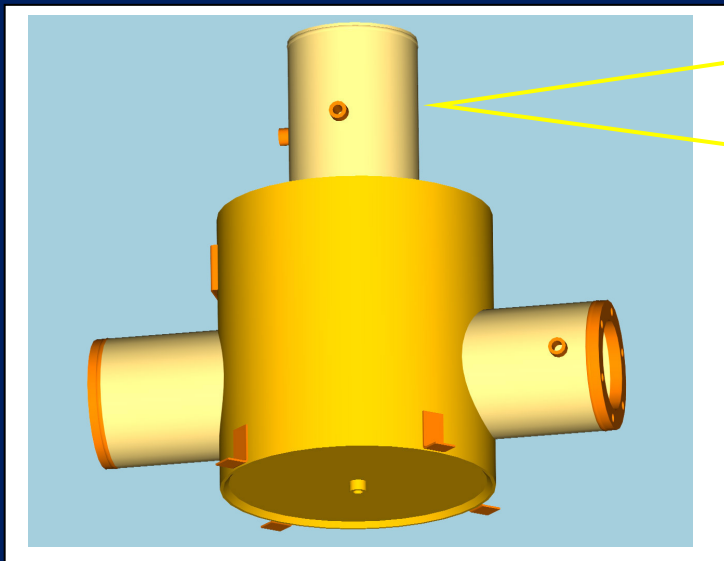

**SEPARATORE VAPORE INCORPORATO
INCORPORATED STEAM SEPARATOR
SEPARATEUR VAPEUR INCORPORE**

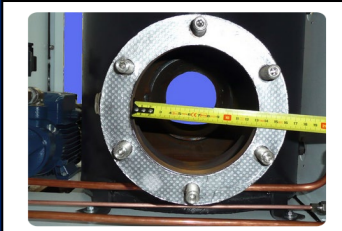

**DIAMETRO FLANGIE 200 / 130 mm
FLANGES DIAMETER 200 / 130 mm
DIAMETRE BRIDES 200 / 130 mm**

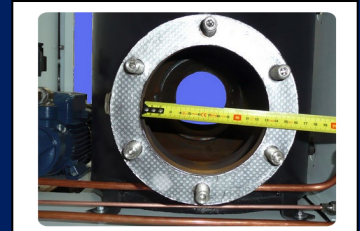

**n.3 RESISTENZE in ACC. INOX 3/8" Cm 22
n.3 ELEMENTS in S.S. INOX 3/8" Cm 22
n.3 RESISTENCES en A.INOX 3/8 " Cm 22**

**n.3 RESISTENZE in ACC. INOX 3/8" Cm 22
n.3 ELEMENTS in S.S. INOX 3/8" Cm 22
n.3 RESISTENCES en A.INOX 3/8 " Cm 22**



**4000 w x n.6 5000 w x n.6
6000 w x n.6 7000 w x n.6
8000 w x n.6 9000 w x n.6**



VASCA INOX 60 Lt
INOX TANK 60 Lts
BAC INOX 60 Lts

CONTROLLO ELETTRONICO ACQUA a 1 SONDA
WATER ELECTRONIC CONTROL with 1 PROBE
CONTROL ELECTRONIQUE D'EAU avec 1 SONDE

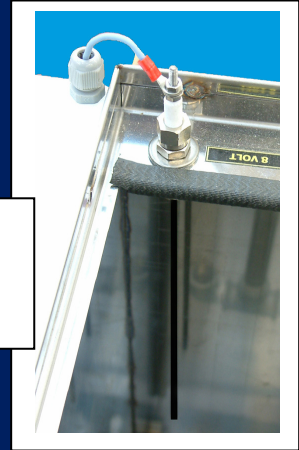

PRESSIONE 5 o 6 Bar
PRESSION 5 or 6 Bar
PRESSION 5 ou 6 Bar

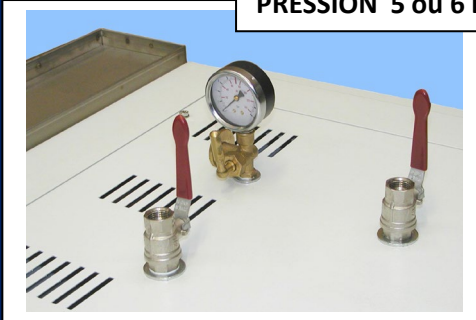

N. 2 USCITE VAPORE ½"
N. 2 STEAM-EXITS ½"
N.2 SORITES VAPEUR ½"

SPESSORE FLANGIE . CIELO . FONDO 2 cm
THICKNESS FLANGES . UP SIDE . BOTTOM 0,8 INCHES
EPAISSEUR BRIDES . CIEL . FOND 2 cm



POMPA ACQUA 120 °c
WATER PUMP 120 ° c
POMPE A EAU 120 ° c

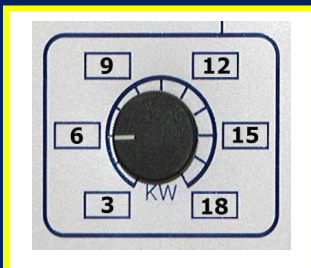

OPTIONAL

VARIATORE POTENZA Resistenze ELETTRONICO 10 % > 100%
ELECTRONIC POWER-ELEMENTS VARIATOR 10 % > 100 %
VARIATEUR ELECTRONIQUE PUISSANCE RESIST. 10 % > 100 %